

Informationen zur LG 23 (LB-HB-022)

Bauspenglerarbeiten.

Abbildung 1: Saumblech



Abbildung 2: Staumstreifen



Abbildung 3: Einlaufblech

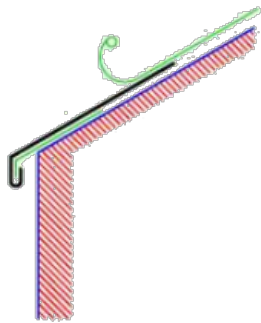

Abbildung 4: Patentsaumstreifen I

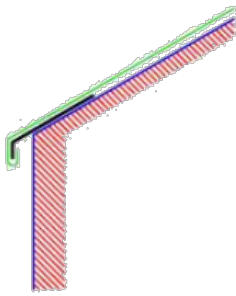

Abbildung 5: Patentsaumstreifen II (Traufenstreifen)

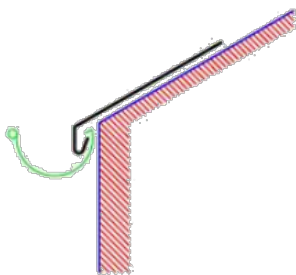

Abbildung 6: Winkelsaum

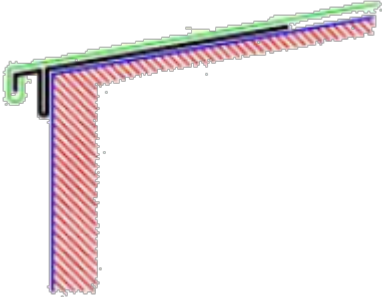

Abbildung 7: Dachichse

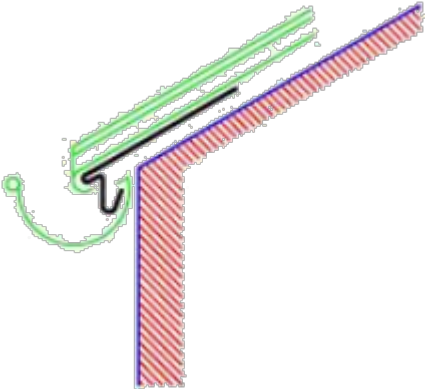

Abbildung 8: Wandeinfassung

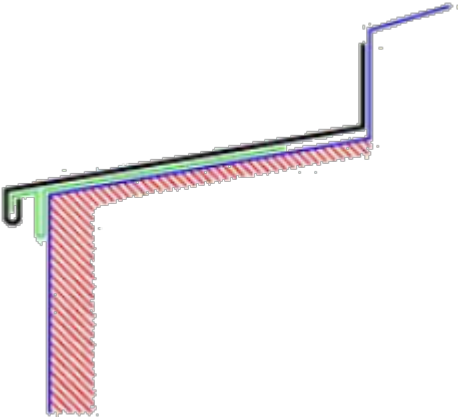

Abbildung 9: Giebeleinfassung

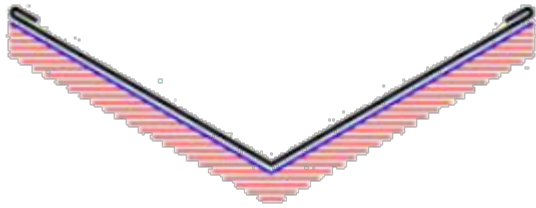

Abbildung 10: Giebeleinfassung mit Stehfalz

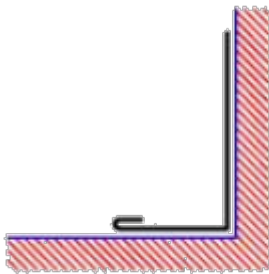

Abbildung 11: Giebeleinfassung vertieft

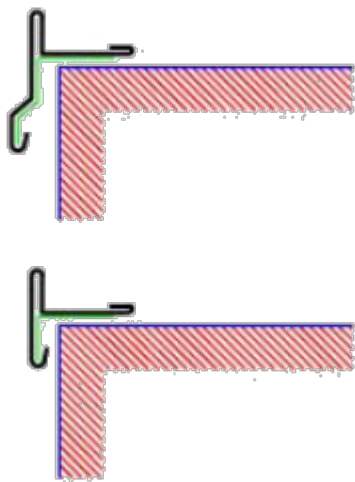

Abbildung 12: Wandeneinfassung vertieft

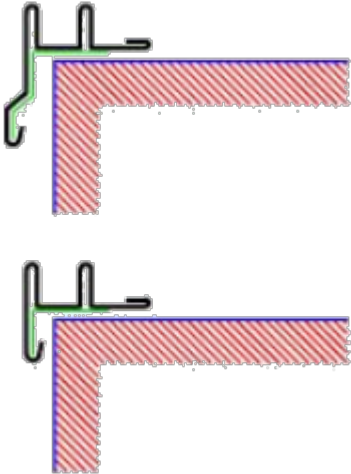

Abbildung 13: Wandeinfassung mit Stehfalz

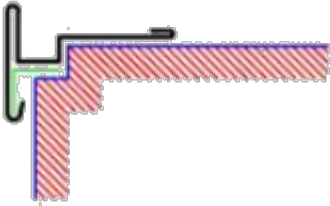

Abbildung 14: Wandeinfassung vertieft mit Stehfalz

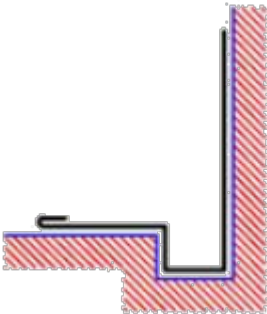

Abbildung 15: Brustblech

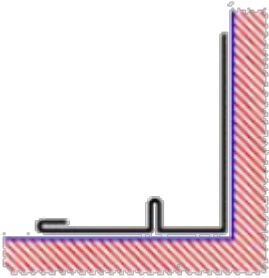

Abbildung 16: Halbfirsteinfassung

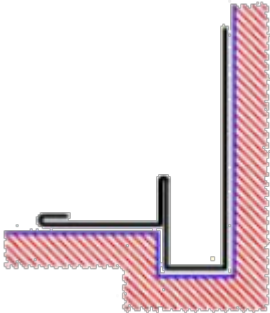

Abbildung 17: First- oder Gratblech

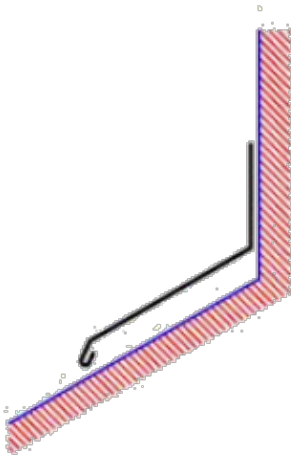

Abbildung 18: Fensterrutsche

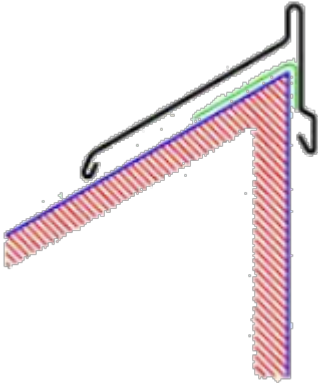

Abbildung 19: Zusatzfalz

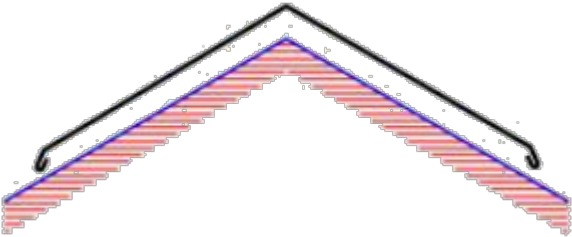

Abbildung 20: Mauerabdeckung

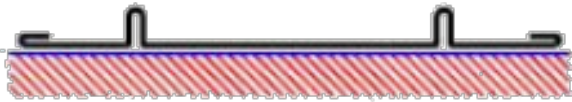

Abbildung 21: Einfassung von gemauerten Rauchfängen - Seitenteil

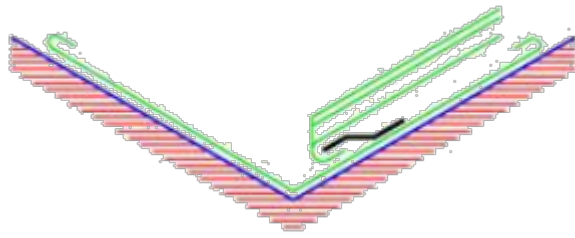

Abbildung 22: Einfassung von gemauerten Rauchfängen - Brustblech, Ichse (Rückenteil)

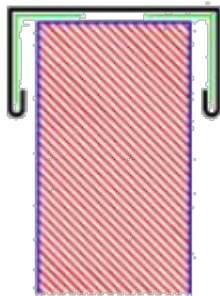

Abbildung 23: Putzleiste

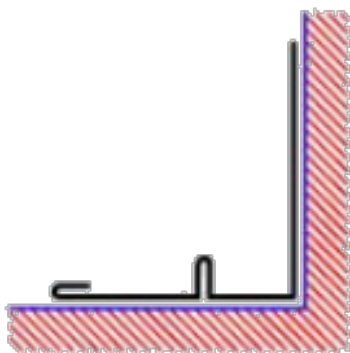

Abbildung 24: Kittleiste

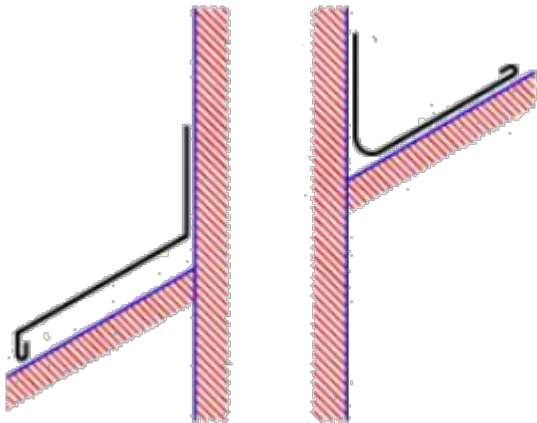

Abbildung 25: Steckputzleiste

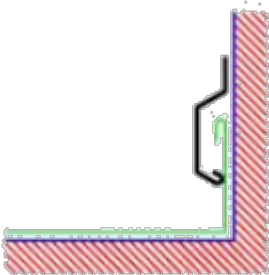

Abbildung 26: Stützeinfassung

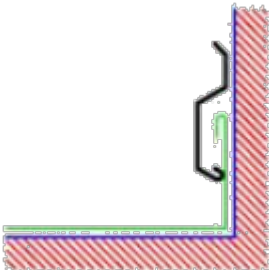

Abbildung 27: Dachdeckung Doppelstehfalz

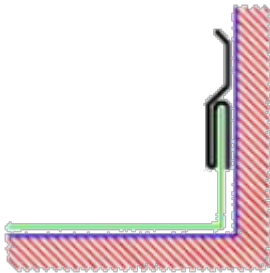

Abbildung 28: Dehnungsfalz

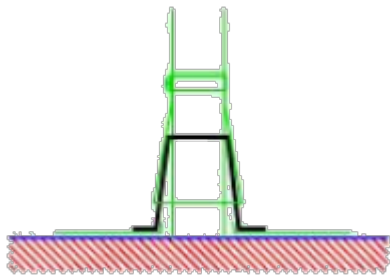

Abbildung 29: Dehnungsleiste

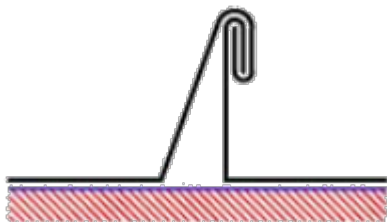

Abbildung 30: Dachdeckung Gefällestufe

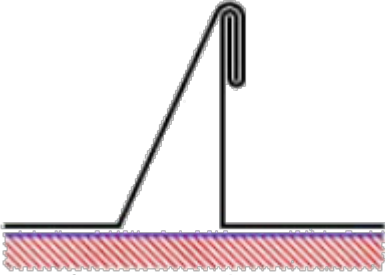

Abbildung 31: Froschmaulluefter

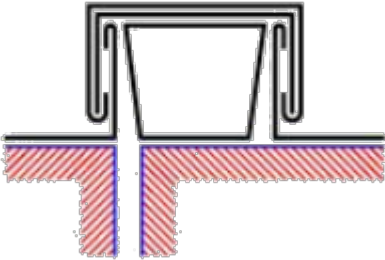

Abbildung 32: Saumrinne mit Schneestützen

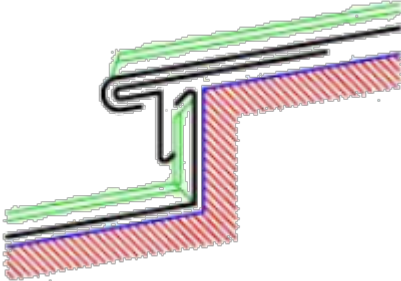

Abbildung 33: Einlege-, Zwischen- Attikarinne I

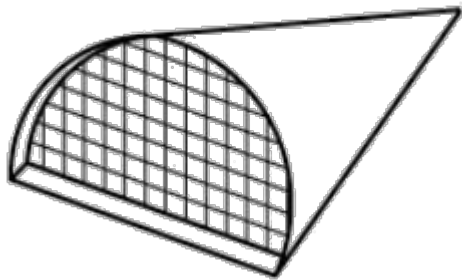

Abbildung 34: Einlege-, Zwischen- Attikarinne II

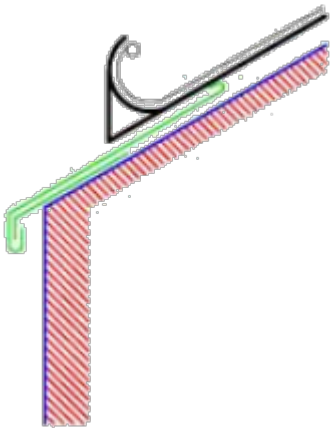

Abbildung 35: Einlege-, Zwischen- Attikarinne III

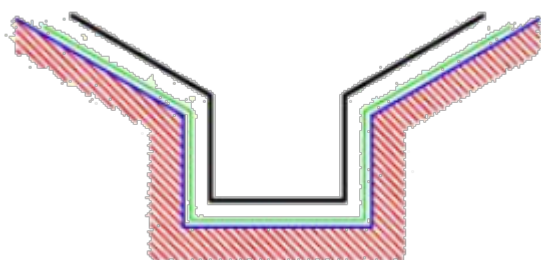

Abbildung 36: Runde Hängerinne

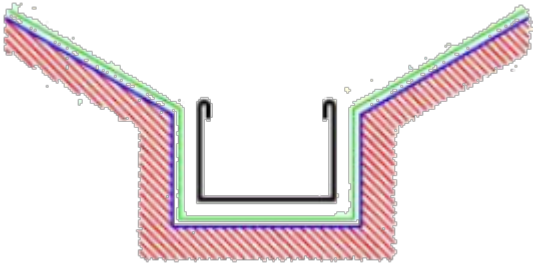

Abbildung 37: Eckige Hängerinne

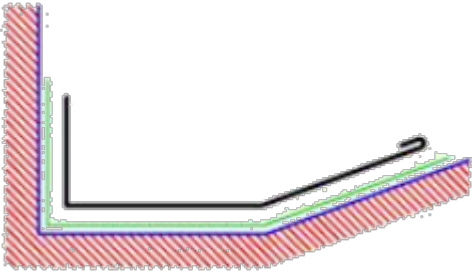

Abbildung 38: Einhängekessel rund

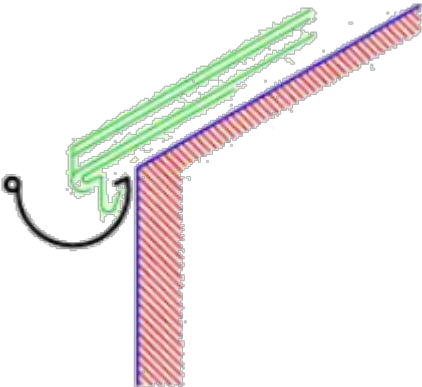

Abbildung 39: Einfassung von Mauerkanten

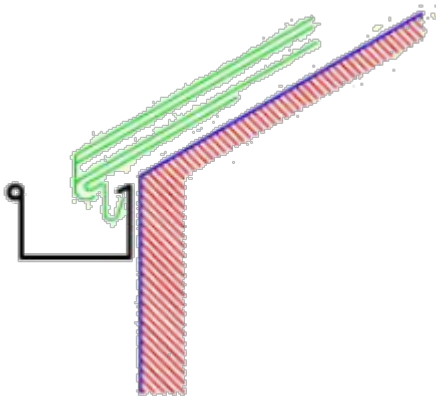

Abbildung 40: Wasserabweiser



Abbildung 41: Wetterschenkel

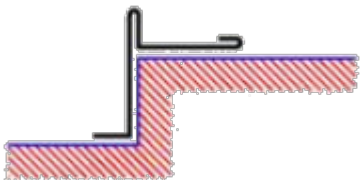

Abbildung 42: Firstlüfter

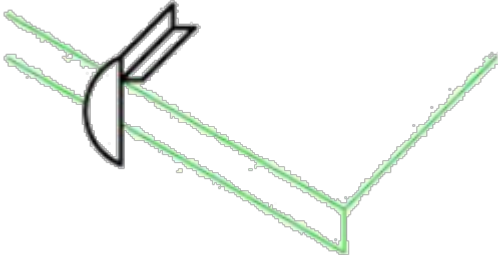

Abbildung 43: Halbfirstlüfter

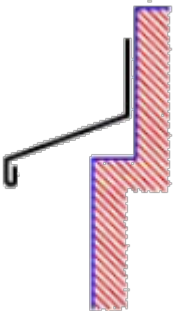

Abbildung 44: Kiesleiste

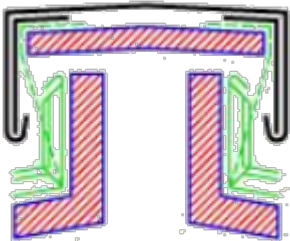

Abbildung 45: Schneefang Einfachrohr

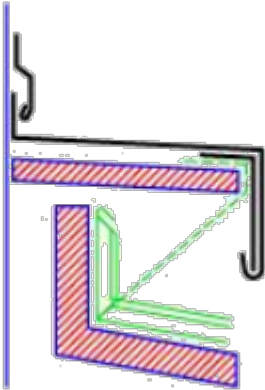

Abbildung 46: Schneefang Doppelrohr

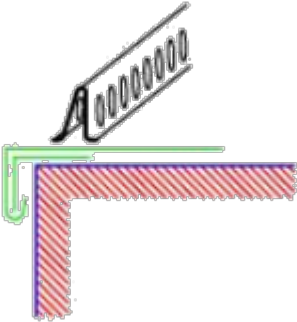

Abbildung 47: Presskiessaum Bitumenabdichtung

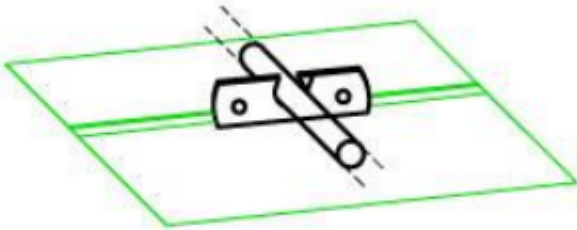

Abbildung 48: Winkeleinfassung Bitumenabdichtung

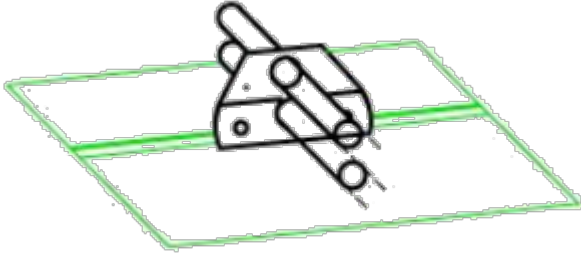

Abbildung 49: Einkopfdila

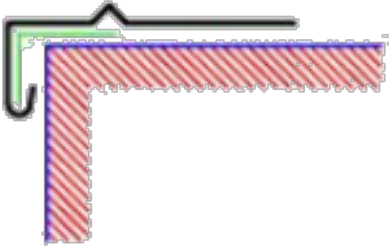

Abbildung 50: Hochzug-Schutzblech

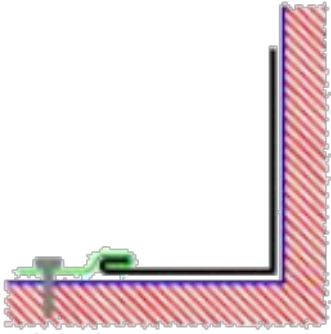

Abbildung 51: Fassaden-Wasserfangkessel

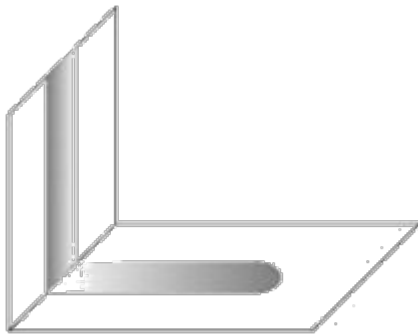

Abbildung 52: Rückstausicherer Stutzen-Messing

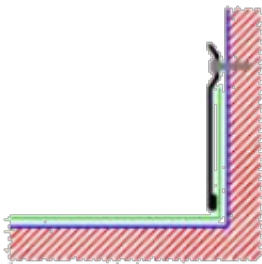

Abbildung 53: Fensterrutsche

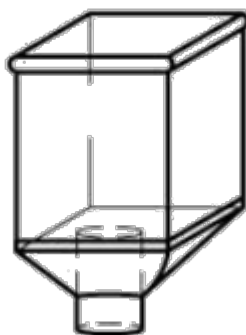

Abbildung 54: Mauerabdeckung, Attikaabdeckung

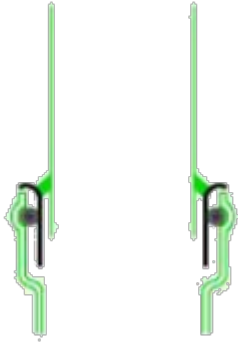

Abbildung 55: Kiesleiste

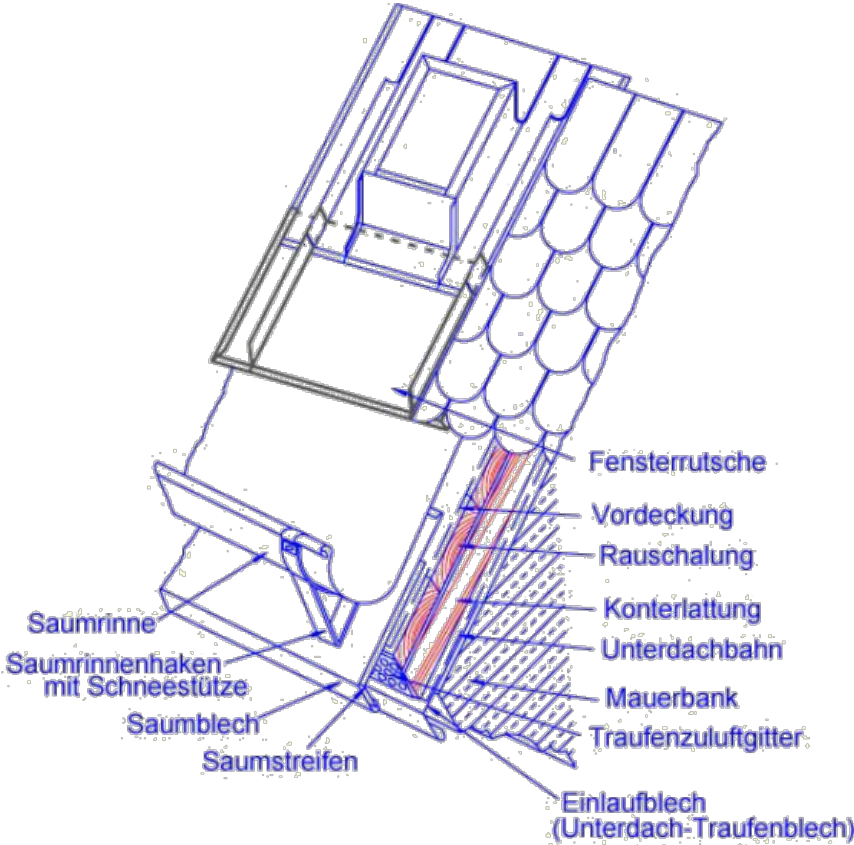

Abbildung 56: Wandeinfassung, An- und Abschlüsse für Abdichtungen und für Hartdeckungen

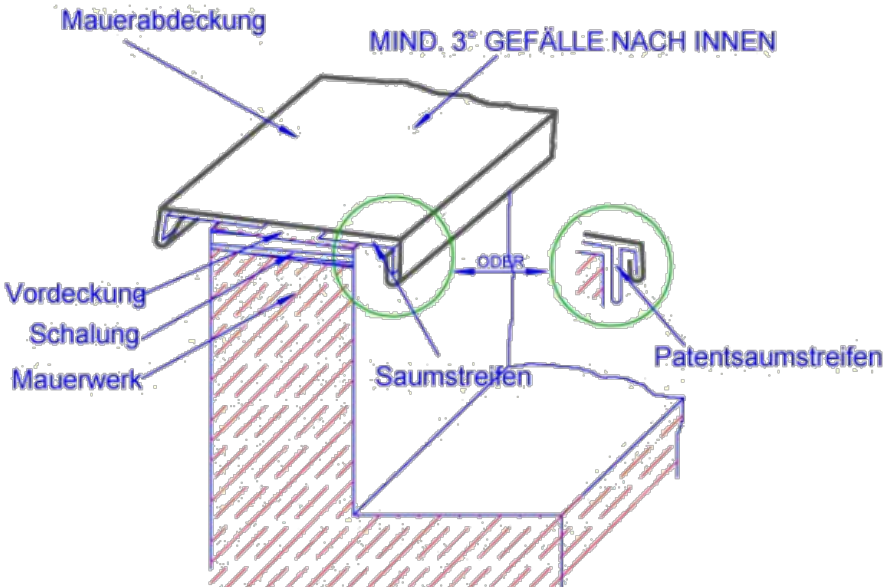

Abbildung 57: Wasserfalz, Wasserlauf

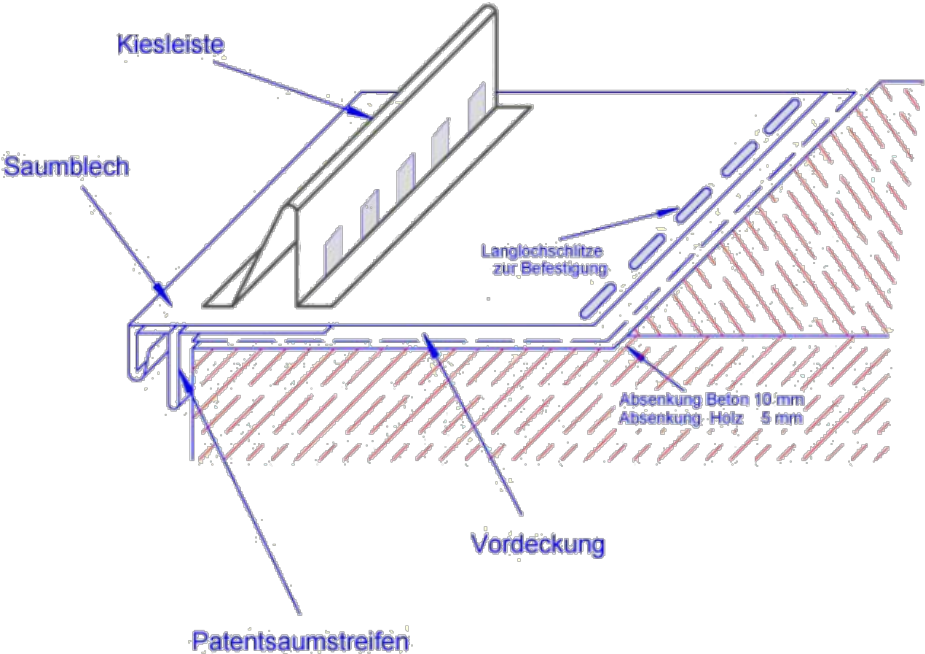

Abbildung 58: Aufgesetzte Firstentlüftung

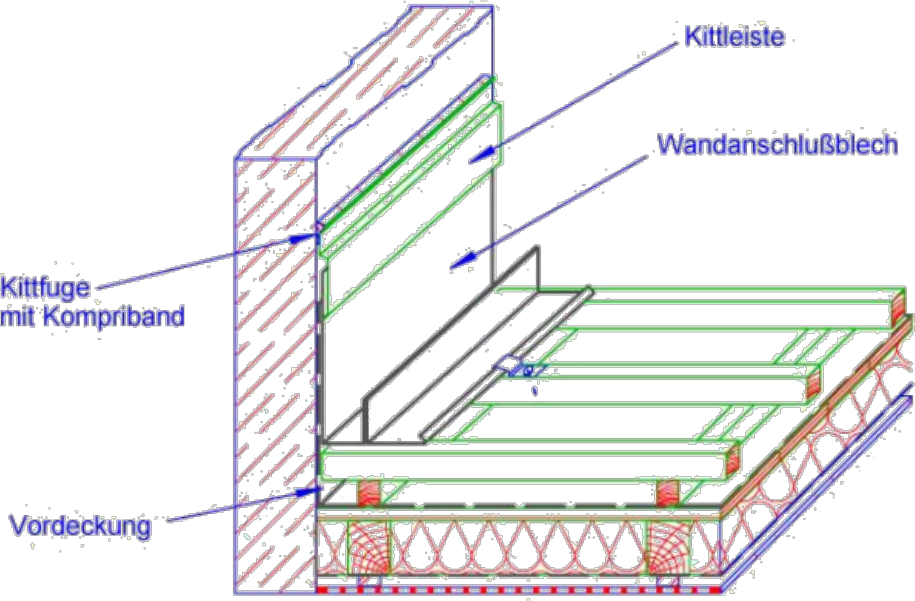
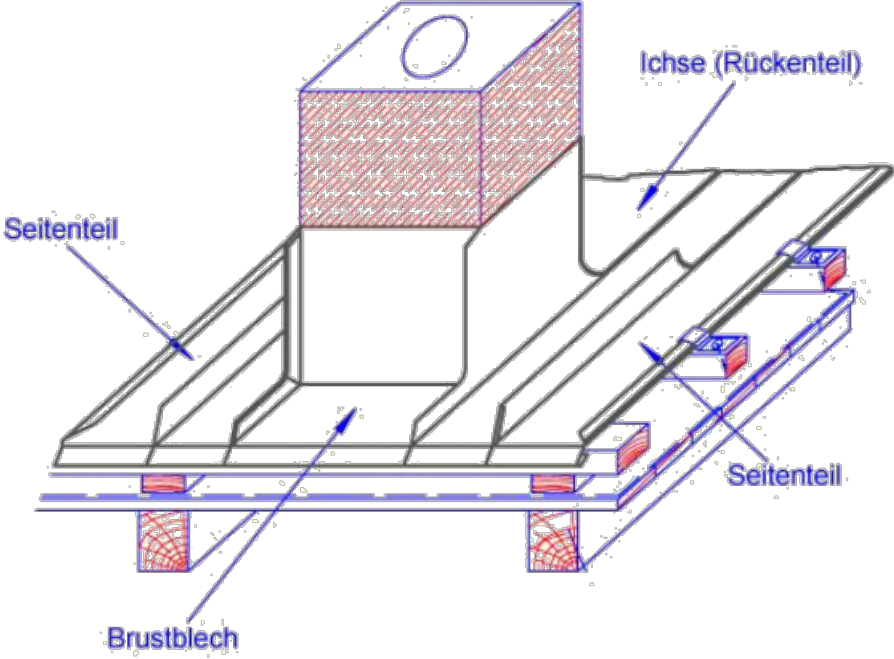